

HEAT TRANSFER AND AIR FLOW ANALYSIS IN DOMESTIC REFRIGERATOR

Syed Asgar Ali¹, Avinash Kumar²
M.Tech.Scholar¹, Asst. Professor²
Department of Mechanical Engineering
AGNOS College of Technology, Bhopal, (M.P.) India.

* Corresponding Author: Syed Asgar Ali

Manuscript Received:

Manuscript Accepted:

Abstract: Currently, refrigeration cycles are very essential in daily life, especially for food storage, fitness and luxury lifestyle. The purpose of this study is to make effective changes to the design of a conventional refrigerant system in order to optimize the performance of the evaporator inside the compartment. The freezer and cooler compartments are designed for 3 configurations in order to verify the consequences of the traditional and perforated flap on the distribution of speed and temperature at the different levels and the comparison of the temperature profiles for the different configurations of the refrigerator compartment. This result is that the average temperature maintained in the freezer compartment and in the refrigerator, compartment is approximately 273K and 286K respectively. Internal compartment 1) the internal temperature without fin system - 279.6K to 282K. 2) The temperature in the rectangular fin system: from 275.6K to 284.7K. 3) The temperature with the perforated fin system - from 273 K to 282 K. The configuration designed for this type of refrigerator, the air temperature in the upper part of the refrigerator is about 5°C higher than the average air temperature, and therefore it is important to avoid placing sensitive products in this location. Perforated fins demonstrated maximum temperature distribution and greater cooling effect.

I. Introduction

In the present time Refrigeration cycles are very important in everyday life, especially when it comes to food storage, fitness and luxurious lifestyle. The basic characteristic of a domestic refrigerator is to keep the temperature of perishable products low. It depends on the excellent performance of the refrigerator [1] [2], which is surprisingly connected to the temperature distribution and the air flow in the compartments.

For refrigerators that support steam compression, numerous studies are conducted, specializing in the distribution of temperature and air flow in the rooms. In literature, we have been able to carry out work related to the examination of air velocity using PIV (particle image counter) technology in combination with 3D digital simulations using a CFD software system [3]. For example, a digital study of airflow and heat transfer was conducted during a natural convection domestic refrigerator. The improvement of the refrigerator model has for a refrigerator with freezer, in which they await the temperature profiles and evaluate them through experiments, which allows to obtain an explicit difference between their results. It develops uniformity of temperature and therefore the flow of air for all walls through a natural convection refrigerator [4]-[6]. The existing numerical simulation of a pressurized convection refrigerator in which the freezer and therefore the compartment of fresh meals in the (synchronized) section are observed with all the differences.

In addition, a few technologies have emerged in in response to the search for different cooling frameworks, including those initiated thermally (sun oriented, geothermal, squander heat, etc.) which emulate a decrease in greenhouse gases substances and don't add to a global warming for the working fluids category [7][8].

In this field, assimilation and dispersion cooling frameworks are all the time utilized in household furniture, for example, lodgings since they are quiet and safe. Despite the fact that these fridges work for a considerable length of time perpetually, their value is restricted to low-cooling fridges [9]. The examination in the field of dispersion ingestion depends to an enormous degree on the correlation of completely one of a kind blends, on the utilization of nano-refrigerants, on the assessment of the arrangements and in this manner on the all-inclusive yield power [10].

The mainly commonly used closed vapor compression refrigerator has six main parts, known as the compressor, expansion device, evaporator, condenser, tube and the circulating working substance, which are known refrigerants. The additional cooling system is

- Cooling by absorption of steam,

- Gas cooling or air cooling
- Cooling by absorption and diffusion

II. Literature Review

Flores et al. [1] presented the analysis of the flow and thermal behavior of a refrigerator compartment, where its cooling effect is based on absorption technology by diffusion. CFD was used to model and simulate the refrigerator. The main objective was to compare the thermal behavior of a plate evaporator with a finned surface (reference refrigerator) and a plate evaporator with a smooth surface (proposed design). Furthermore, the study concluded with a discussion of the velocity distribution and the trajectory lines of temperature and velocity. This was also observed under the influence of the position of the grille within the compartment. In addition, the performance of the refrigerator was evaluated.

Onrawee Laguerre et al. [1] This work was led to survey heat move by common convection in residential fridges without ventilation. Just the cooler compartment was analyzed for 3 setups: void fridge, fridge with glass racks and fridge with item stacking. Exploratory and numerical methodologies are utilized. The recreations were performed utilizing the CFD (Computational Fluid Dynamic) programming, contemplating or disregarding the exchange of brilliant heat. The resulting conditions were expected: consistent evaporator temperature, three-way laminar wind stream. The numerical outcomes show the separation of the temperature inside the cell (hot zone above and cold zone underneath) for all designs. A correlation of the determined air temperature with the trial esteems shows a legitimate understanding if radiation is thought about.

Belman-Flores et al. [2] this article presents an investigation of the temperature separation inside the cooler and cooler compartments of a residential constrained convection fridge during a story arrangement. As a matter of first importance, the examination is performed through test tests during which boundaries like temperature, cold velocity and vitality utilization are estimated. CFD is then wont to show and reenact the fridge. The consequences of the main model show an insufficient warm working profile which, contrasted with a substitution plan proposition, shows a far superior appropriation of the wind current inside the last mentioned and along these lines an increasingly uniform temperature inside the new produce room. Tentatively, the new structure proposition speaks to a lower number of ON stages for the blower analyzed thereto of the primary fridge inside the equivalent working conditions.

Bayer O et al. [3] This examination intends to reproduce fluid stream and temperature dispersion during a solitary business cold room utilizing temperature esteems decided tentatively as limit conditions indicated for steady divider temperature. Free convection in refrigeration applications is assessed as a three-dimensional non-direct stream issue (fierce, transient and coupled). the strategy of moving brilliant heat is furthermore included inside the examination. predictable with the outcomes, thinking about the results of radiation doesn't essentially change the temperature dissemination inside the fridge. Be that as it may, warming rates are intensely affected. The stream inside the compartment is then dissected utilizing a little request displaying technique called rectified symmetrical disintegration (POD) and in this way the vitality substance of different spatial and worldly modes existing inside the stream is analyzed. The outcomes show that roughly 95% of the whole stream vitality are regularly spoken to utilizing a solitary spatial mode.

Yang K.S. et al. [4] Temperature fluctuations within the freezer and refrigerator are found to be in phase, while temperature fluctuations within the vegetable room are approximately out of phase with the opposite two rooms. The simulations show that the planning of the air passage and its positions can affect the uniformity of the temperature within the refrigerator, but the air flow is strongly influenced by gravity. We also note that the cold room has the worst temperature inequalities. so as to enhance temperature non-uniformity, a modified design is proposed, which contains the planning of the air passage with appropriate positions of the inlet openings within the freezer and cold room. Although these changes have reduced the utmost temperature difference and therefore the average square of temperature fluctuations within the cold cell from 7.17°C to three $.57^{\circ}\text{C}$ and from 3.17°C to 1.55°C , respectively.

Devendra Singh Dandotiya et al. [5] presented the experimental performance of a domestic refrigerator equipped with a phase change material (PCM) based condenser in parallel with the normal air cooled metal tube condenser for the Indian climate. It is recommended to run the refrigerator with the PCM condenser when the ambient temperature is highest during the day. Otherwise, the condenser temperature in the air-cooled condenser would not rise significantly due to the enormous heat of the transforming storage capacity of the PCM. The COP of the PCM-based condenser was 28% higher than that of the air-cooled condenser for one hour and dropped to three when the PCM temperature reached 33.

III. Methodology

Experimentation

1. Collecting information and data related to the Refrigerator system.
2. A fully parametric model of the Refrigerator system is generated using CatiaV5
3. Model obtained in Step 2 is analyzed using ANSYS 18.2 (FLUENT).
4. Finally, the results obtained from ANSYS are compared in the result section.

Method of ANSYS Analysis

Building the Model

The CATIA gives the accompanying ways to deal with model age: Creating a strong model inside CATIA. The business cooler utilized in this investigation was of little limit (0.003 m^3) as found in Figure. 2. The outer elements of the trial fridge were $0.4 \text{ m} \times 0.35 \text{ m} \times 0.50 \text{ m}$ (width x profundity x tallness) and the divider thickness was roughly 0.037m . Inside the cooler there was an aluminum plate with rectangular blades, which was clearly in contact with the evaporator tube, and by this infers, the heat move was practiced in the food compartment. The plate comprised of 19 fins and was $0.3\text{m} \times 0.3 \text{ m}$. If there should be an occurrence of aperture plate, by numerous CFD examination at various measurement take distance across of the opening for puncturing is 0.026m .

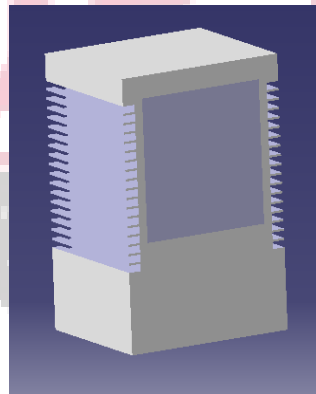

Fig. 1: Refrigerator model in CATIA V5

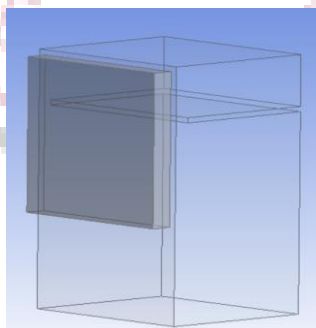

Fig. 2: Refrigerator model Air Domain

Meshing

In ANSYS CFD works on finite element analysis (FEA). The fundamental thought of FEA is to make estimation at just limited (finite) no. of focuses and afterward introduce the outcome for the whole domain. Any object has boundless level of opportunity and it's simply not possible to solve the issue in this organization. And the FEA decreases the level of opportunity from vast to limited with the assistance of lattice or discretization. Meshing quality is measure by two parameter first is skewness (maximum element near to 0) and second is orthogonal (maximum element near to 1). In every one of the three models, the basic work was gotten with acceptable quality reliable with Equivalent Size Skew boundary, won't to define the level of distortion of the components, where of the 90% components present a value just about zero. Proportionate size symmetrical boundary is also utilized for illustrating the level of distortion of the components, where 90% of the components present a value just about one.

Case1- Rectangular Finned Surface

The mesh created in rectangular finned work is shown in Fig 3. The total number of node generated is 169407& Total No. of Elements is 156198 for Refrigerator with Rectangular fin.

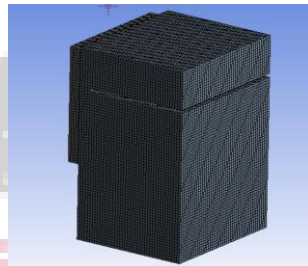

Fig. 3: Meshing Total No. of Node 169407& Tot. No. elements 156198

Case2-Without Finned Surface

The mesh created in without finned work is shown in Fig. 4. The tot. Node is generated 102720& Tot. No. of Elements is 478747 for Refrigerator without fin.

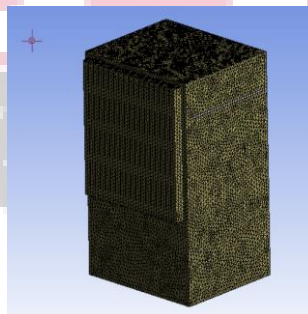

Fig. 4: Meshing Tot. Number of Node 102720& Tot. No. of Elements is 478747.

Case3-Perforated Finned Surface

The mesh created in perforated finned work is shown in Fig. No. 5. The total Node is generated 366357 & Total No. of Elements is 1848509 for Refrigerator with perforation.

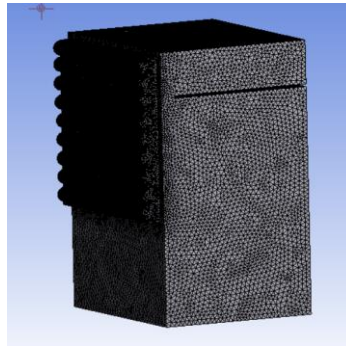

Fig. 5: Meshing Tot. No. of Nodes: 366357 & Tot. No. elements: 1848509

IV. Result Analysis

Case 1:-Without Finned Surface

Computational fluid dynamic analysis of the Simulations of Plate evaporator without-finned surface.

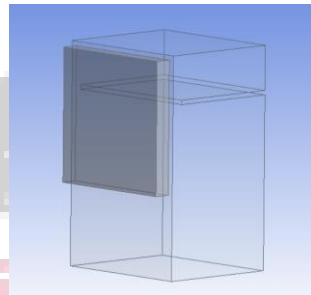

Fig 6: Without Finned Surface

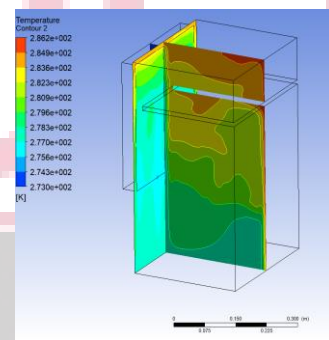

Fig 7: Plate Evaporator without Finned Surface for Temperature Contour

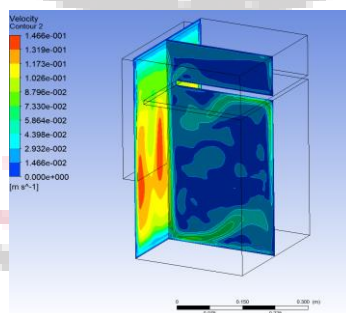

Fig 8: Contour of Velocity for Plate-Evaporator without Finned-Surface

Case2:- With Rectangular Finned Surface

CFD Simulation of Plate evaporator with rectangular finned surface

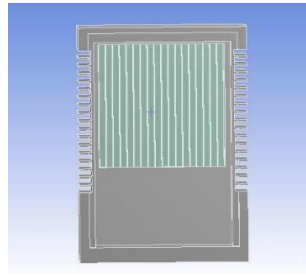

Fig. 9: with Finned Surface for Plate-Evaporator

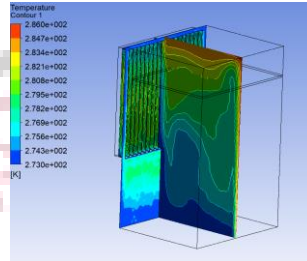

Fig. 10: Contour of temperature Plate-Evaporator with Finned Surface

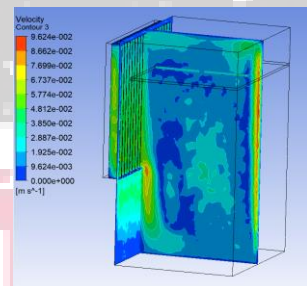

Fig. 11: Contour for Velocity Plate Evaporator with Finned Surface

Case: 3-:with Perforated Finned Surface

CFD Simulation of Plate evaporator with perforated finned-surface

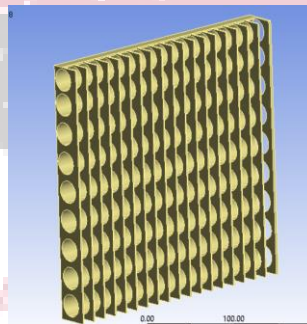

Fig. 12: With Perforated Finned Surface of Plate-Evaporator

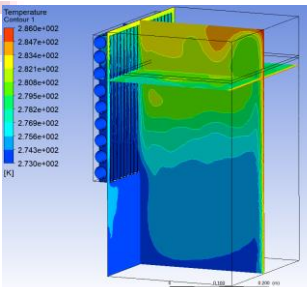

Fig 13: Contour for Temperature Plate Evaporator with Perforated Finned Surface

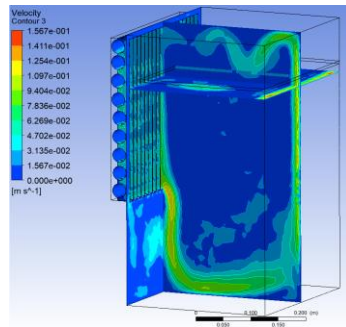

Fig 14: With Perforated Finned Surface contour Velocity for Plate-Evaporator

5.4 Temperature-Analysis

Results were obtained in order to study of the velocity and temperature distributions inside the domestic refrigerator. Drop in maximum and minimum temperature (Table 1) is observed in perforated fin refrigerator. The drop in temperature is due to increment in the surface area which in turn increases the heat transfer rates.

Table 1: Maximum-Minimum Temperature

Refrigerator	With fin	Without fin	Perforated fin
Minimum Temperature (Plate Side Temperature)	279.6K	275.6K	273K
Maximum Temperature (Door Side Temperature)	281K	284.7K	282K
Average	280.3K	280.15K	277.5K

5.5 Temperature-Distribution in Horizontal plane for different cases

In the temperature distribution of the horizontal plane compartment and it is related to the natural movement of the difference density caused by the temperature gradient. The temperature distribution for a non-grooved plate, a ribbed rectangular plate, and a grooved plate perforated on a horizontal plane in the center of the compartment. The average temp. is 281.915K in the horizontal plane and flap plates without flaps, rectangular flap plates are 278.114K and perforated flap plates are 277.734K.

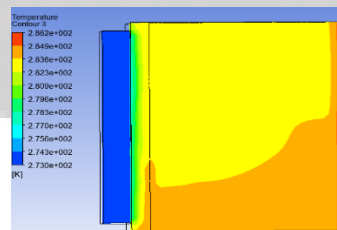

Fig. 15: Without Finned Plate

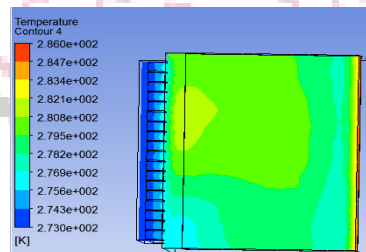

Fig. 16: With Rectangular Finned Plate

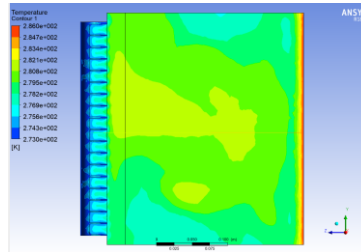

Fig. 17: With Perforated Finned Plate

Performance analysis (table 2) for different refrigerator model, in this study all calculation were done on horizontal plane by using below COP equation which is based on diffusion absorption cycle, and we also use reference paper1(calculation for cooling capacity Q_{evap}) and paper4(Data for thermal capacity of bubble pump $Q_{bp}=65W$), and after calculation we found that perforated finned evaporator plate has highest COP among other finned plate evaporator.

Table 2: Comparison of COP for different refrigerator model

Refrigerators	T_p .[K]	$T_{airc.}$ [K]	$Q_{evop.}$ [W]	COP
Without finned	280.454	281.91	6.29	0.09677
With finned	280.11	278.14	8.727	0.13426
Perforated finned	280.04	277.73	9.98	0.1535

V. Conclusion

The Computational fluid dynamic simulation of the heat transfer and air flow is performed in the cold room of a domestic refrigerator. Inside the compartments three configurations with rectangular ribs and without ribs and perforated ribs are examined. The freezer model is the temperature distribution of confirming the idea that there are the stratification, a cold zone on the bottom and the highest hot zone.

- The average temp maintained in the refrigerating and freezer compartment is about 273 K & 286 K respectively.
- Whatever the configuration studied for this type of refrigerator, the air temperature at the top of the refrigerator is about 5°C higher than the average air temperature, and therefore it is important to avoid placing sensitive products in this position.
- While perforated finned showed greatest Temperature conveyances and giving higher cooling impact.

This research works can be used in future as a tool in order to study the influence of operating conditions on the temperature and velocity fields such as change in evaporator temperature, change dimensions of the evaporator and the change percentage of product-occupied volume inside the refrigerating compartment

References

- [1] J.M. Belman-Flores, A. Gallegos-Muñoz, Analysis of the flow and temperature distribution inside the compartment of a small refrigerator, Applied Thermal Engineering, Volume 106, 2016, pp. 743-752.
- [2] Onrawee Laguerre, Sami Ben Amara "Numerical simulation of air flow and heat transfer in domestic refrigerators" Journal of Food Engineering, vol. 81, issue 1, pp. 144-156, July 2007.
- [3] Belman-Flores, J.M.; Gallegos-Muñoz, A.; Puente-Delgado, A. "Analysis of the temperature stratification of a no-frost domestic refrigerator with bottom mount configuration". Appl. Therm. Eng. 2014, 65, 299–307.
- [4] Bayer, O.; Oskay, R.; Paksoy, A.; Aradag, S. "CFD simulations and reduced order modeling of a refrigerator compartment including radiation effects". Energy Convers. Manag. 2013, 69, 68–76.
- [5] Yang, K.S.; Chang, W.R.; Chen, I.Y.; Wang, C.C. "An investigation of a top-mounted domestic refrigerator". Energy Convers. Manag. 2010, 51, 1422–1427.
- [6] Devendra Singh Dandotiya, Nitin Banker "Performance Enhancement of a Refrigerator Using Phase Change Material-Based Condenser: An Experimental Investigation" DOI: 10.1142/S2010132517500328 October 2017.
- [7] Jasmin Geppert, Rainer Stamminger "Analysis of effecting factors on domestic refrigerators' energy consumption in use" Energy Conversion and Management 76:794-800 · December 2013
- [8] Saji Raveendran, Joseph S Sekhar "Experimental studies on domestic refrigeration system with brazed plate heat exchanger as condenser" Journal of Mechanical Science and Technology 30(6):2865-2871 · June 2016.
- [9] Juan Manuel Belman-Flores, Juan Manuel Barroso "Enhancements in domestic refrigeration, approaching a sustainable refrigerator - A review" Renewable and Sustainable Energy Reviews 51:955-968 · November 2015.

- [10] O.R Olatunji, Olayinka S. Ohunakin “Performance of a Limited Charge of R600a and LPG Refrigerants in a Domestic Refrigerator Using R134a Refrigerant in Different Ambient Conditions” *Journal of Physics Conference Series* 1378:022101 · December 2019.

